

# HD Bullet Camera

## User Manual

Thank you for purchasing our HD-TVI bullet camera. Please read this manual carefully for correct use of the product and keep it for reference purposes.

### Warnings and Cautions

#### Disclaimer

This manual may contain several technically incorrect places or printing errors. The updates will be added into the new version of this manual. The content is subject to change without notice.

#### Avoid Electric Shock

To prevent electric shock, do not remove screws or cover.

#### Avoid excessive moisture

Do not use strong or abrasive detergents when cleaning camera body. Clean with dry cloth or mild detergent, wiping gently.

#### Do not use camera beyond prescribed voltage range.

Only use included power supply. Ensure power input source conforms to local voltage. Voltage outside of range could cause damage or abnormal performance.

#### Termly Inspection

A few parts of the device shall be replaced regularly due to their average enduring time.

#### Never attempt to disassemble the camera privately.

It may result in internal components damaged.

Do not place the camera in extreme hot or cold environment.



Use only under temperature conditions between -40°C and +70°C. Provide good ventilation when using in high temperature conditions.

Do not drop the camera or subject it to physical shock.

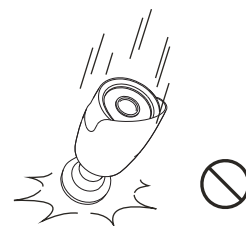

It may cause production malfunction.

Do not aim camera at sun or extra bright place.

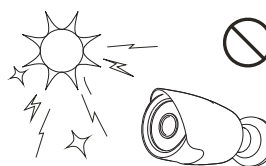

Strong light will degrade image quality and could cause damage.

Avoid touching the camera lens.



The lens is the most important component of the camera. Be careful not to smear it with fingerprints.

### Components and Accessories

1	Camera	
2	User manual	
3	Screwdriver	
4	Screws	
5	Drill Template	

### Overview

This series of the camera supports varifocal lens and prime lens.

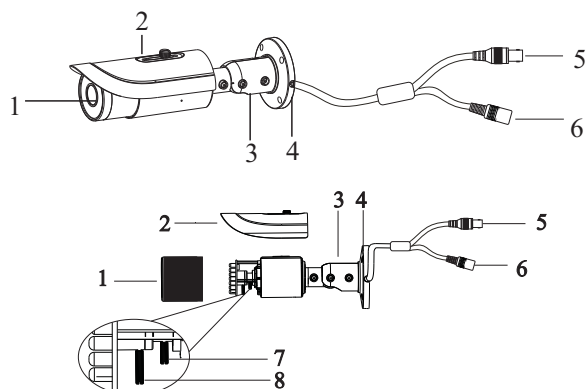

1	Lens Cover	5	Video Cable
2	Sun Shield	6	Power Cable
3	Bracket	7	Zoom
4	Mounting Base	8	Focus

### Connecting to Monitor

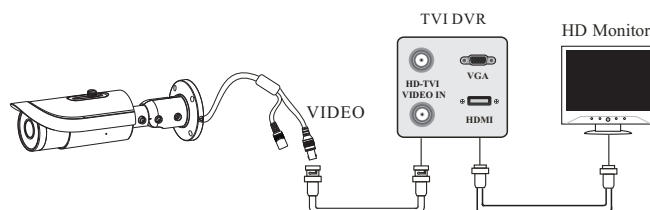

### Connecting to Power

Connect the adapter to the power input connector in accordance with the camera. The recommended adapter specification for the camera is DC12V.

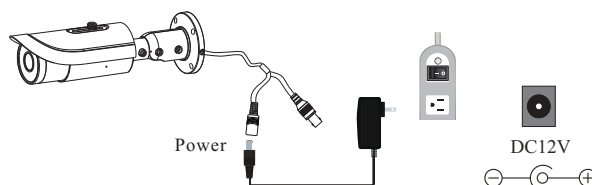

## ► Installation

-  \* This series of product supports prime lens and varifocal lens. If your camera is prime lens, please skip the step of focus and zoom adjustment.  
\* Before you start, please make sure that the wall or ceiling is strong enough to withstand three times the weight of the camera.

1. Attach the drill template to the place where you want to fix the camera and then drill 4 screw holes and 1 cable hole ( if you want to route the cables through the mounting base ) according to the drill template.

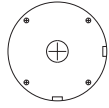

2. Route the cables and connect the power cable and video cable.  
3. Secure the mounting base with camera to the ceiling or wall with screws as shown below.

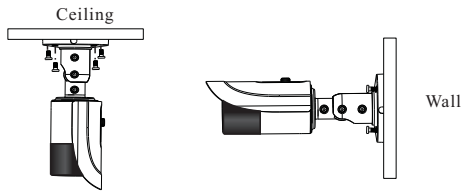

4. Bracket adjustment. Before adjustment, preview the image of the camera on a monitor and then loosen the fixed screws to adjust the panning and tilting position of the camera. After you adjusted, tighten the fixed screws.

Page 5

## ► Installation

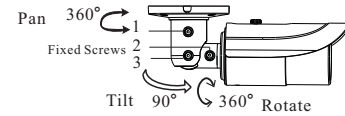

5. Focus and zoom adjustment ( If the model you get is prime lens, please skip this step). Remove the lens cover and then adjust the focus and zoom screws to get a clear image. Finally, tighten these two screws and the lens cover.

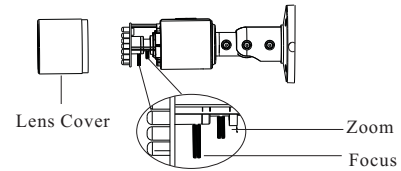

6. Remove the protection film softly to complete the installation.

-  \* This installation should be made by a qualified service person and should confirm to all local codes.



### Correct Disposal of This Product

If the camera no longer functions or can no longer be repaired, it must be disposed of according to regulations reading electronic waste. By not disposing of electronic items in household waste you will not only be following the law, but contributing the protection of the environment.

Page 6

## ► Features

This series of cameras adopt the latest HD-TVI technology and advanced circuit design, feature high definition and sensitivity, low noise and distortion and support HD video transmission with the common coaxial cable, ensuring the requirement of the HD monitoring in the traditional surveillance system.

### ● High Resolution

Adopt high performance HD-TVI sensor, providing high definition and clear image, up to 720P / 1080P resolution.

### ● High Transmission Performance

Real-time transmission with high speed and long distance.

### ● ICR Auto Switch

The filter will filter infrared light during the daytime and change to normal at night to ensure a high sensitivity and clear image.

### ● Color-B/W Auto Switch

The camera will display color image in daytime and become monochrome automatically at night.

### ● Auto White Balance

Adjust the color temperature according to the environment automatically.

### ● 3-axis Adjustment

Adopt advanced 3-axis mechanism design to meet different mounting requirement by flexibly adjusting the lens into the required angle.

### ● DNR

Reduce noise from brightness and color signal to save storage room under low illumination condition.

Page 7

## ► Specifications

Model	HD-TVI IR Water-proof Bullet Camera	
Image Sensor	1 / 3" CMOS	
Pixels	1280 x 720	1920 x 1080
Signal System	PAL / NTSC	
Min. Illumination	0 Lux ( LED ON )	
Lens	8 mm ( 6 mm, 12 mm, 2.8 ~ 12 mm optional )	
IR Visible Distance	30 ~ 50 m	
IP Rank	IP 66	
Video Out	BNC x 1	
Resolution	720 P ( 1280 x 720 )	1080 P ( 1920 x 1080 )
Frame Rate	30 fps ( 60Hz ), 25 fps ( 50Hz )	
ICR	Yes	
DNR	Yes	
S / N Ratio	> 52 dB ( AGC OFF )	
Electronic Shutter	1 / 50s ~ 1 / 67500s	
AGC	Yes	
White Balance	Auto White Balance	
Power	DC12V ± 10%	
Temperature	- 40°C ~ 70°C	
Humidity	10% ~ 90%	
Dimension ( mm )	Φ 109 x 284	
Weight ( net )	1000 g	

Page 8